

6 Covers

6.3.4 Dual full opening covers

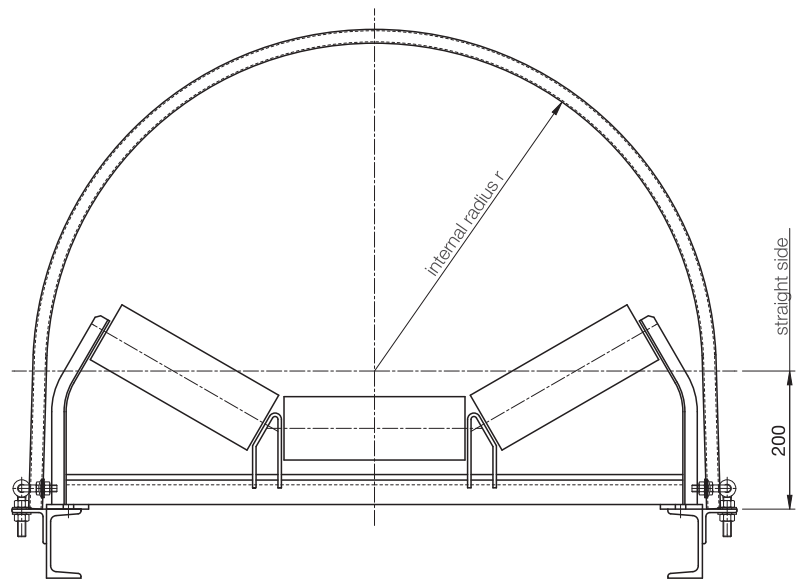
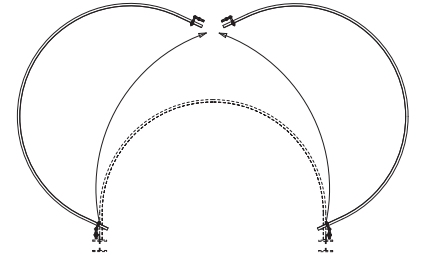
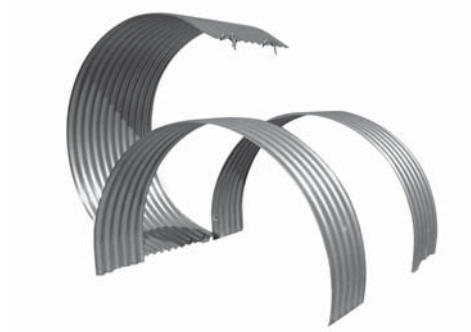

CPTA 1, 180° standard straight side 200 mm – dual full opening covers

Ordering code example for dual full opening covers:

CPTA 1 1600/1025 180/1064 P200 FR H30 Z35

type —————
 belt width/radius —————
 degrees/ length —————
 straight size (standard 200) —————
 with punching F —————
 fixing type R (see page 298) —————
 punching height —————
 material/covering (standard Z35 - see page 292) —————

These covers are produced from galvanised sheet steel corrugated section 76/18 thickness 0,75 mm, suited to all belt conveyors with belt widths ranging from 400 to 1800 mm.

They belong to CPTA 1 series but they are characterised by a special fixing system, that allows their opening on both sides and makes belt inspection easier on both sides in the same conveyor point. All control operations and maintenance interventions to the plant result in the end to be made particularly easily.

Cover Type	Belt width mm	Radius r mm	Standard Length 1064 at 180° kg
CPTA 1	400	350	11.7
	500	400	12.9
	650	475	14.7
		550*	16.5
	800	575	17.0
		650*	18.8
	1000	675	19.5
		750*	21.3
	1200	800	22.5
		875*	24.3
	1400	900	24.9
	1600	1025	27.8
1800	1125	30.2	

(*) radius on request

Dimensions and mounting lay-outs

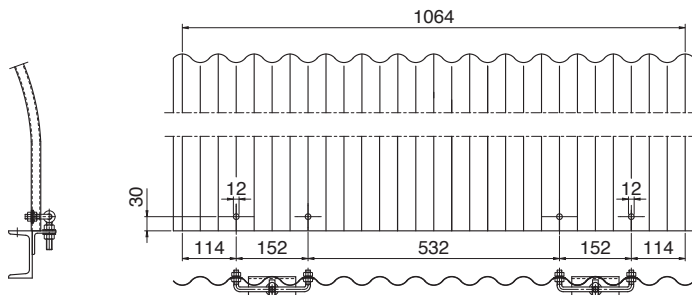

Composition with all dual full opening covers

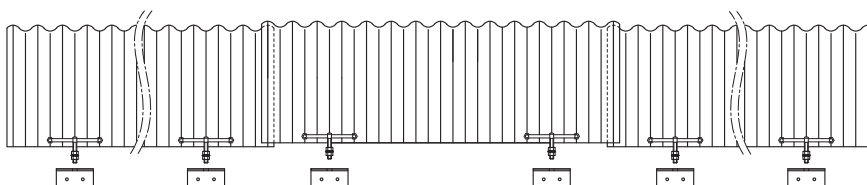

Composition with alternated fixed covers and dual full opening covers

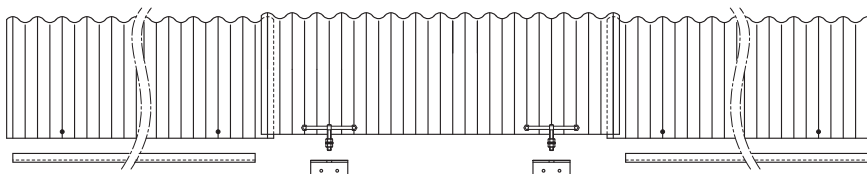

Fixing accessories

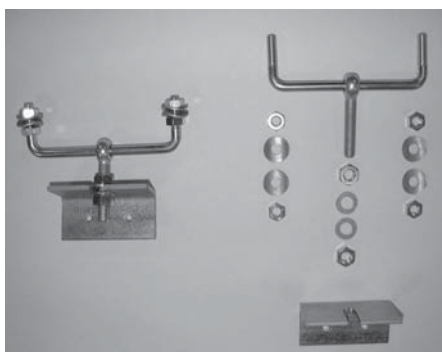

Fixing with hinges type R

The standard supply includes the following galvanised components:

- 1 hinge
- 4 nuts M10
- 4 washers
- 2 nuts M12
- 2 flat washers
- 1 bracket 50x50x100

Quantity to be ordered:
4 sets for each cover
Ordering code: CPTA, R

